

Relaxed Continuous Views of Discrete Event Systems: considerations on Forrester Diagrams and Petri nets*

E. Jiménez^(*), J. Júlvez^(*), L. Recalde^(*), M. Silva^(*)

(*) Dept. Ingeniería Eléctrica. Área de Ingeniería de Sistemas y Automática.
Universidad de La Rioja. Luis de Ulloa 20, E-26004, Logroño (Spain).
e-mail: emilio.jimenezm@die.unirioja.es

(**) Departamento de Informática e Ingeniería de Sistemas
Universidad de Zaragoza. María de Luna 3. CP-50015 Zaragoza
e-mail: {silva,lrecalde,julvez}@unizar.es

Abstract - Petri nets (PNs) constitute a formal paradigm for discrete systems. Some discrete models can be relaxed into continuous models. Infinite server semantics continuous Petri nets (ISSCPNs) is one of the most relevant timed interpretation of Continuous PNs. ISSCPNs can be seen as piecewise linear systems. Forrester Diagrams (FD) are specific modelling tools inside System Dynamics, a methodology for the analysis of complex continuous systems. This paper explores and compares the modelling power of both formalisms, ISSCPNs and FD. Previous comparative views focused on the formalisms and on positive and compartmental systems, constitute the basis of this work. The comparison is complemented taking into account the interpretation of linear ordinary differential equation systems (LODES), the information delays and some methodological considerations. ISSCPNs permit to model any LODES when known upper and lower bounds of the state variables exists. Therefore systems with cyclic behaviour or delays in the information can be modelled.

Keywords: Continuous Petri nets, Forrester diagrams, relaxation of discrete event dynamic systems, positive systems, expressive power.

1 Introduction

PNs constitute a well-known family of discrete event dynamic formalism over the nonnegative naturals. Although PNs models are originally discrete event models, their relaxation through continuization transforms them into continuous models. At the price of losing certain possibilities of analysis, this permits to obtain some advantage, such as avoiding the state explosion problem inherent to the discrete systems and taking advantage of the extensive theory about continuous dynamic systems. Although not all PN systems allow a "reasonable" continuization [1], this relaxation is possible in many practical cases, leading to a continuous-time formalism: continuous PNs. Different timed interpretations lead to

different firing/flow policies. One of the most relevant is ISSCPNs, the one that will be dealt with in this paper. Under this interpretation PNs are piecewise linear systems over the nonnegative reals.

FD, a specific modelling tool inside System Dynamics (SD), provides a graphic representation of continuous dynamic systems based on (eventually non linear) ordinary differential equation systems (ODES). They have been widely used to model complex systems with a friendly graphic representation, but they are totally equivalent to ODES. An interesting class of linear ODES are positive linear systems, whose state variables take only nonnegative values, the same as Continuous PNs. Another special class of positive linear systems are compartmental systems, which are systems composed of interconnected compartments or reservoirs.

Following [2] and [3], ISSCPNs are compared with FD, and with linear positive systems and compartmental models, in order to deepen into their expressive power, that is, the type of behaviour that they can present and the kind of systems that can be modelled with them.

ISSCPNs are introduced in Section 2. Section 3 presents them as piecewise LODES, and their positivity is analyzed; control arcs are presented, and the expressive power of ISSCPNs to model dynamical systems (including compartmental systems) is determined. Section 4 shows the capacity of ISSCPN to model and simulate linear systems based on FD, what leads to information delays or cyclic behaviours. Finally in Section 5 the conclusions obtained in this paper are summarized.

2 Continuous Petri nets and Forrester diagrams

2.1 Petri nets definitions

PNs constitute a well-known formal paradigm for the modelling, analysis, synthesis and implementation of systems that "can be seen" as discrete. Their basic concepts and notations are introduced, for instance, in [4], [5]. We will just remark that a system is a structure $N = \langle P, T, \text{Pre}, \text{Post} \rangle$ provided with an initial marking over P , m_0 . Pre and

* 0-7803-8566-7/04/\$20.00 © 2004 IEEE.

○ Supported by a grant from DGA ref B106/2001

(*)Part supp. by CICYT/FEDER TIC2001-1819 and DPI2003-06376

Post represent the static structure of the model, from which the token flow matrix, $C = \text{Post} - \text{Pre}$, can be deduced. A Petri net structure can also be represented as a bipartite directed graph, in which places p are usually represented as circles and transitions t as bars. The marking changes by the firing of transitions. Starting from a PN system, a state (or fundamental) equation can be written: $\mathbf{m} = \mathbf{m}_0 + C \cdot \sigma$, where $\sigma \in \mathbb{N}^m$ and $\mathbf{m} \in \mathbb{N}^p$.

The set of reachable states of a discrete PN system may easily become extremely large. This is known as the state explosion problem. A way to try to overcome this problem, is to continuousize the system, what allows the use of different mathematical tools (convex geometry and linear programming, differential equations ...).

PNs can be interpreted with marking in the non-negative reals (Continuous PNs) to model the relaxed continuous approximation of the discrete model. The firing is modified in the same way, that is, a transition t is enabled at \mathbf{m} iff $\forall p \in {}^*t, \mathbf{m}[p] > 0$. Its enabling degree is defined as $\text{enab}[t] = \min_{p \in {}^*t} \{\mathbf{m}[p] / \text{Pre}[p, t]\}$.

In a continuous PN we may consider the derivative of the state equation with respect to time. This way we obtain that $\dot{\mathbf{m}} = C \cdot \dot{\sigma}$, plus the initial condition $\mathbf{m}(0) = \mathbf{m}_0$. Let us call $\mathbf{f} = \dot{\sigma}$, since it represents the flow through the transitions. If $\mathbf{f}(\tau)$, where τ represents time, is defined by an interpretative extension then the timed evolution of the continuous PN can be obtained. Different firing semantics have been defined for continuous Petri nets [6], [7]. Infinite servers semantics will be used in this paper. Under this firing semantics the flow through a transition t_i is defined as $f[t_i] = \lambda[t_i] \cdot \text{enab}[t_i]$ where $\lambda[t_i]$ is a positive real constant representing the internal speed of transition t_i .

2.2 Forrester diagrams definitions

SD constitute a modelling methodology that permits to systematize the creation of continuous models based on systems of non-linear multivariable time dependent differential equations. FD are specific modelling tools inside SD [8] that provide a graphic representation of dynamic systems (see Figure 1), modelling quantitatively the relationships between the parts by means of some symbols, which correspond to a hydrodynamic interpretation of the system.

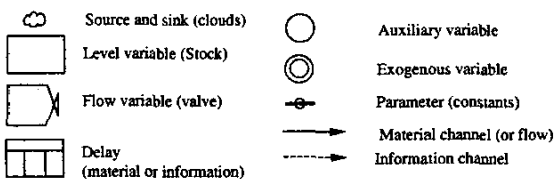

Figure 1: Forrester Diagrams elements

The *levels* correspond to the state variables in systems theory. They represent the variables whose evolution is more significant for the study of the system. The levels accumulate "material" from material channels, which are controlled by the valves (flow variables). *Valves* define the behaviour of the system, since they determine the speed of the material flow (through the *material channels*) according to a set of associated equations. The equations depend on the information that the valves receive from the system (levels, auxiliary variables and parameters) and from the environment (*exogenous variables*). The information is transmitted instantaneously through *information channels*. *Auxiliary variables* correspond to intermediate steps in the calculation of the functions associated to the valves, but they can always be removed. The *clouds* represent sources and sinks, that is, a non-determined (infinite) amount of material, and the parameters are constant values of the system. The interaction of the system with the exterior is represented with the exogenous variables, which have an evolution that is assumed to be independent from the evolution of the system. The *delays* can affect the material or the information transmission, but in both cases they do not introduce more description capacity, because they just correspond to a compact notation of elements that produce these delays.

A differential equations based model is directly derived from a FD, and the interest of the hydrodynamic analogy is that indicates that a FD model is equivalent to an (eventually non-linear) ODES, and vice versa.

3 Petri nets and ordinary differential equation systems

In the previous section it has been seen that the evolution of a ISSCPN is described by the system:

$$\begin{aligned} \dot{\mathbf{m}}(\tau) &= C \cdot \mathbf{f}(\tau) \\ \mathbf{f}(\tau)[t_i] &= \lambda[t_i] \cdot \text{enab}(\tau)[t_i] \\ \mathbf{m}(0) &= \mathbf{m}_0 \end{aligned}$$

Thus a continuous Petri net under infinite servers semantics becomes a piecewise linear system. The switch between two linear systems is triggered by a change of the place giving the minimum in the expression for the enabling degree.

3.1 On positivity

Broadly speaking, positive systems are systems whose state variables take only nonnegative values. A positive system automatically preserves the non-negativity of the state variables, i.e., if non-negativity constraints on the state are added, they are redundant.

More formally, let $\Sigma(1)$ be a linear system:

$$\dot{\mathbf{x}}(t) = \mathbf{A} \mathbf{x}(t) + \mathbf{B} \mathbf{u}(t) \quad (1)$$

Definition 1. [9] Σ is said to be positive iff for every nonnegative initial state and for every nonnegative input its state is nonnegative. Then the positive orthant \mathfrak{X}_n^+ is a nonnegative invariant set. If $B=0$, the system is said to be uncontrolled or unforced.

Note that positivity in linear systems can depend on the basis of the input as well as on the basis of the state space. Some non-positive system can be transformed into another equivalent positive system by a basis change in the state space. This is the reason why some authors define positive systems by requiring the existence of an invariant set (without requiring, however, that such an invariant set be the positive orthant).

Theorem 1. [9] A linear system (1) is positive, iff A is a Metzler matrix and B is nonnegative (a matrix/vector is nonnegative if all its elements are nonnegative and a square matrix is Metzler if non-diagonal elements are nonnegative).

According to Definition 1, ISSCPNs are positive systems (the fact that the flow of a transition is proportional to its enabling degree ensures the nonnegativity of the marking). Nevertheless, the matrices A_i of the linear systems ruling the evolution of the net (recall that an ISSCPN is a piecewise linear system) can be non Metzler matrices. In a ISSCPN the switching between linear systems is triggered by a change in the place giving the minimum in the expression of the enabling degree.

The evolution of the net system in Figure 2 is driven by a linear system with matrix A_1 if $x_1 \leq x_2$ and with matrix A_2 otherwise (if $x_1 = x_2$ both systems are equivalent). Neither A_1 nor A_2 is a Metzler matrix, however the system is positive.

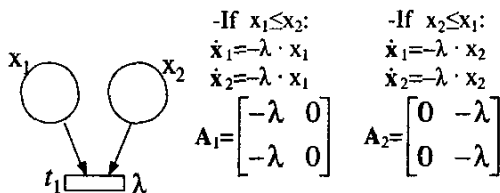

Figure 2: A ISSCPN whose associated linear systems have non Metzler matrices.

3.2 Control Arcs in PNs. Expressive power of ISSCPNs.

Control arcs will be introduced in this section. A control arc is defined on a couple $\{place, transition\}$ and allows to model instantaneous control of the flow of the transition without modifying the marking of the place. It will be shown that by using control arcs any bounded LODES can be represented by an equivalent ISSCPN.

Let us describe how a control arc can be added to a ISSCPN. Consider an ISSCPN with a vector of internal speeds λ and incidence matrices Pre and $Post$. Let us assume that the flow of a transition t is desired to be $\lambda[t] \cdot m[p]$ all along the evolution of the system for a given place p that is not an input place of t . In other words, we want the flow of transition t to be controlled by place p . Recall that the flow of t is $f[t] = \lambda[t] \cdot \min_{p \in \text{pre}[t]} \{m[p] / Pre[p,t]\}$. Therefore, in order to achieve our goal it is necessary that p is an input place of t and that it is always giving the minimum in the expression for the flow. This can be done by adding an arc going from p to t with weight k . We will assume that k is big enough to ensure that p always gives the minimum. If the internal speed of t , $\lambda'[t]$, is made k times faster ($\lambda'[t] = k \cdot \lambda[t]$) then $f[t] = \lambda'[t] \cdot m[p]$. In order to avoid that transition t consumes fluid from p , a new arc going from t to p with weight k is added to the net. This way, the flow of t is controlled by p , but the marking of p is not modified by the firing of t . Summing up, to put a control arc between $\{p, t\}$ of weight k , two arcs of weight k have to be added (from p to t and from t to p), and the internal speed of t has to be multiplied by k .

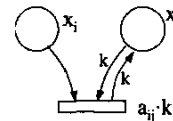

Figure 3: A control arc with weight k .

Note that in a control arc $\{p, t\}$ the weight k is assumed to be big enough to ensure the control of the transition. If the markings of the input places of t are strictly positive and the marking of p is upperbounded then such a k does always exist. However, if the marking of one of the input places tends to zero or the marking of p tends to infinity, no finite k exists such that p gives the minimum in the expression for the enabling degree.

An ideal control arc is defined as a control arc with its constant k equals to infinite. The use of ideal control arcs allows to control transitions even when the marking of an input place tends to zero or the marking of p tends to infinity. Ideal control arcs represent an extension in the modelling power of ISSCPN and can be used to empty a place in finite time. They are equivalent to the information arcs in FD (in linear and nonnegative restricted systems).

The following lemma states that by using regular control arcs (no ideal control arcs) any LODES that has a positive and known lower and upper bounds can be modelled by an equivalent ISSCPN.

Lemma 1: For any LODES with positive and known lower and upper bounds there exists an ISSCPN having identical behaviour.

Proof. Let us consider the following LODES $\dot{x} = A \cdot x + B \cdot u$ of dimension n . Each scalar equation

associated to this equation can be written as $\dot{x}_i = \sum_j a_{ij} \cdot x_j + \sum_k b_{ik} \cdot u_k$. Let q be the number of nonzero elements of A , r the number of nonzero elements of B and m the dimension of u . Let us consider an ISSCPN with $n+m$ places and $q+r$ transitions. Every transition is associated to a nonzero element of either matrix A or B . Let us first show how the expression $\sum_j a_{ij} \cdot x_j$ can be modelled by an ISSCPN. The modelling of $\sum_k b_{ik} \cdot u_k$ follows immediately by considering that the markings of the last m places correspond to the values of the input vector u .

Let us define the internal speed of the transition t associated to a_{ij} as $\lambda[t]=|a_{ij}|$. Let us assume that the term a_{ij} of the expression $\sum_j a_{ij} \cdot x_j$ is negative. In order to model $\dot{x}_i = a_{ij} \cdot x_j$ it is enough to add a control arc between the place associated to x_j and the transition associated to a_{ij} . Let l be the lower bound of x_i and u the upper bound of x_j . The weight k of the control arc has to fulfill $u/k < l$ to ensure that the flow of transition a_{ij} only depends on the marking of place x_j . By adding an arc going from place x_i to transition a_{ij} the expression $\dot{x}_i = a_{ij} \cdot x_j$ is modelled. The rest of the negative terms in $\sum_j a_{ij} \cdot x_j$ are modelled in the same way.

In order to model a positive term a_{ij} a control arc is required between between the place x_j and the transition a_{ij} . Since a_{ij} is positive the expresión $\dot{x}_i = a_{ij} \cdot x_j$ is modelled by adding an arc from transition a_{ij} to place x_i . In this case the weight of the control arc is not restricted since x_j is the only input place to a_{ij} and hence its marking will always give the minimum in the expression for the flow of a_{ij} .

From Lemma 1, the following Proposition is immediately obtained.

Proposition 1: For any LODES whose state variables have a known lower and upper bound there exists an ISSCPN that represents the evolution of the LODES in the positive reals.

Proof: Any LODES with known lower bounds can be shifted to the positive reals by means of a change of variable. According to Lemma 1 there exists an equivalent ISSCPN for the shifted system.

Recall that by introducing ideal control arcs it is possible for a place to control a transition even if its marking stretches to infinity. Therefore the use of ideal control arcs allows to model also those LODES that are not upper bounded.

3.3 Donor and Recipient Continuous Positive Systems

Compartmental systems are a particular case of positive systems. They are composed of a finite number of subsystems (compartments), interacting by exchanging material among the compartments and with the

environment. A compartmental system can be represented as a graph (with compartments as nodes) with an associated interpretation (*compartmental networks*). The level of each compartment, x_i , changes according to the input and output flows through the arcs, i.e., $\dot{x} = \sum_k f_{ki} - \sum_j f_{ij}$.

Inside compartmental systems generation of matter is forbidden. This means that for every column of A the sum of its elements is non-positive, i.e., $\sum_j a_{ij} \leq 0$. Hence, all the eigenvalues have a non-positive real part, and so the systems are either asymptotically or marginally stable. If it is an unforced system, then $x(t)$ is bounded; if it is a closed system then the "material" is constant, and otherwise there are losses in the system.

The flows can be defined according to different semantics: (pure) *donor controlled* when f_{ij} depends only on x_i ($f_{ij} = b_{ij} \cdot x_i$, in the linear case), (pure) *recipient controlled* when f_{ij} depends only on x_j ($f_{ij} = c_{ij} \cdot x_j$ in the linear case), *donor and recipient controlled* if f_{ij} depends on both x_i and x_j (for example, $f_{ij} = d_{ij} \cdot x_i \cdot x_j$). In general any kind of control can be defined, i.e., the flows may depend (global function) on any set of variables. Linear donor controlled systems are positive systems (in the sense of not to present negative states), but pure recipient controlled system are not, in general, positive systems.

Any linear compartmental system based on donor controller can be "naturally" *simulated* by means of a PN, because a basic element in the evolution of PNs is that behaviour is of the consumption/production type, that is, the common practice in PNs is to define the flow according to the enabling, i.e., the input places. That is not the idea in a recipient controlled system, but it is possible to represent recipient controlled compartmental systems with ISSCPN control arcs.

4 Forrester diagrams and infinite server semantics continuous petri nets

As commented in Section 2, FD constitute a graphic representation of (eventually non positive and non linear) ODES, and they are mainly used to simulate the evolution of dynamic systems. Furthermore, it has been shown in section 3 that ISSCPNs allows to simulate the evolution of ODES with positive states, (or with the possibility of being transformed into another system with positive states).

4.1 Behaviours types modelled with ISSCPN

Let be a general case of unforced linear ODES, $\dot{x}(t) = A x(t)$, with dimension 2. Its solution is $e^{At} \cdot x(0)$. Certain particular cases that exemplify the types of behaviour of this system are shown in Table 1. Exponential (positive and negative), linear, oscillating, hyperbolic and even sine growing behaviours can be seen.

A	eig(A)	e^{At}
$\begin{bmatrix} \pm a_1 & 0 \\ 0 & \pm a_2 \end{bmatrix}$	$\pm a_1, \pm a_2$	$\begin{bmatrix} e^{\pm a_1 t} & 0 \\ 0 & e^{\pm a_2 t} \end{bmatrix}$
$\begin{bmatrix} 0 & 0 \\ a & 0 \end{bmatrix}$	$a, 0$	$\begin{bmatrix} 1 & 0 \\ a t & 1 \end{bmatrix}$
$\begin{bmatrix} 0 & a \\ 1/a & 0 \end{bmatrix}$	$1, -1$	$\begin{bmatrix} h \cos t & a h \sin t \\ (h \sin t)/a & h \cos t \end{bmatrix}$
$\begin{bmatrix} 0 & a \\ -1/a & 0 \end{bmatrix}$	$i, -i$	$\begin{bmatrix} \cos t & a \sin t \\ (-\sin t)/a & \cos t \end{bmatrix}$
$\begin{bmatrix} 0 & a \\ -1/a & 1 \end{bmatrix}$	$\frac{1}{2} + \frac{\sqrt{3}}{2}i, \frac{1}{2} - \frac{\sqrt{3}}{2}i$	$\frac{e^{t/2}}{\sqrt{3}} \begin{bmatrix} -\sin \frac{\sqrt{3}t}{2} + \sqrt{3} \cos \frac{\sqrt{3}t}{2} & \dots \\ -\frac{1}{a} \sin \frac{\sqrt{3}t}{2} & \dots \end{bmatrix}$

Table 1: Examples of behaviour that can be modelled with ISSCPNs in positive systems.

Let us suppose a particular system with a material storage (St) and a staff of employees (E). The material is decreased due to the sales (S), which are assumed to be constant in time, and it is increased with the production (P), which is proportional to the number of employees. On the other hand, E varies with the contracting (C), which is proportional to the difference between the desired storage (DSt) and the present St . Figure 4 shows the FD that models this system.

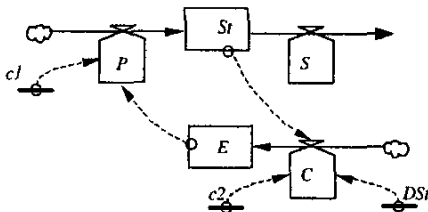

Figure 4. DF of a storage with employees system.

The differential equations system corresponding to that FD and its matrices are,

$$\begin{aligned} P(t) &= c_1 \cdot E(t) \\ C(t) &= c_2 \cdot (DSt - St(t)) \\ \frac{dSt(t)}{dt} &= P(t) - S \\ \frac{dE(t)}{dt} &= C(t) \end{aligned} \quad A = \begin{bmatrix} 0 & c_1 \\ -c_2 & 0 \end{bmatrix} \quad B = \begin{bmatrix} -S \\ c_2 DSt \end{bmatrix}$$

The eigenvalues of A are pure complex conjugated, independently of the values of c_1 and c_2 (due to the structure of the system), and their temporal evolution is oscillatory, sine shaped and with no damping. It can be described as:

$$\begin{aligned} St &= w \cdot \sin((c_1 \cdot c_2)^{1/2} \cdot t) + DSt \quad (3) \\ E &= w \cdot (c_2/c_1)^{1/2} \cdot \cos((c_1 \cdot c_2)^{1/2} \cdot t) + S/c_1 \end{aligned}$$

where w depends on the initial state, and it is computed as

$$w = ((St(0) - DSt)^2 + ((E(0) \cdot c_1 - S)/(c_1 \cdot c_2))^2)^{1/2}$$

So, if the storage is represented *versus* the employment, although the sales are constant a cyclic behaviour appears, with the parameters shown in Figure 5. As a curiosity, this type of behaviour (cyclic even with continuous inputs) was the origin of Forrester's studies, which were the source of System Dynamics.

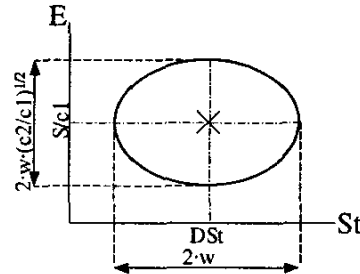

Figure 5. Behaviour of the system described in Figure 4

If $St(0) = DSt$ and $E(0) = S/c_1$, then the system is stable. It is also important to emphasize that this system has only physical sense when the levels (stored elements and number of employees) have positive values, but the system of differential equations is non positive, and negative employment and storage can be reached for some initial conditions. Therefore, the constraint for non negativity ($St, E \geq 0$) must be additionally included in order to obtain a correct model.

The system with the non negativity constraint can be modelled with continuous PN (Figure 6) but it must be taken into account that C , which can be positive or negative, must be implemented as a combination of a flow of new contracts and a flow of dismissals, both positive.

Note that two places have been used (those with unitary marking) in order to get a constant flow with ISS, and control arcs have been necessary to explicitly select the places that provide the information to the transitions with synchronizations. The system will be described by (3) whenever $St \geq 1/k_\infty$ and $E \geq St/k_\infty$. Recall that k_∞ represents a finite constant as big we want (eventually tending to infinite).

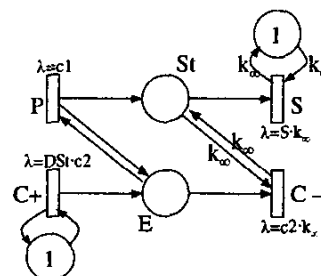

Figure 6. ISSCPN equivalent to the system in Figure 4 restricted to positive values.

It is also important to note that an appropriate value of k_∞ in the PN depends on the minimum values that St and E can reach (and then on the initial marking). For instance, if $c_1=c_2=1$, $St(0)=9$, $DSt=10$ and $E(0)=S=12$, then k_∞ does not need to be higher than 1. Figure 7 shows simultaneously the evolution of the constrained system (modelled with ISSCPN or FD with constraints) and the non restricted one (modelled with ODES or FD without constraints). Both are similar from the initial state to the first intersection with the horizontal axis (point *a* in the graphic). Figure 7a presents St versus E, and Figure 7b shows the temporal evolution of the state variables.

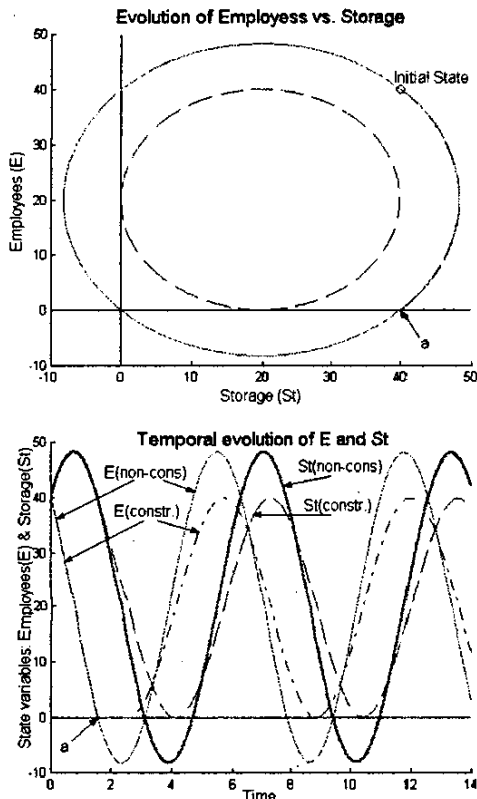

Figure 7: Evolution of the system with $c_1=c_2=1$, $St(0)=E(0)=40$; $DSt=10$, $C=V=20$ from constrained (broken line) and no constrained (unbroken line) models.

4.2 Information delays in PNs

Models with material and information delays are frequently used in FD. In both cases delays are modelled either as one first order system, or as several ones in series (usually three), but no additional modelling elements are used. In PNs material delays are often used, similar to material delays in FD, but similar delays can also be modelled with the information. Table 2 shows both types of delays in FD and in their equivalent ISSCPNs. Note that the dynamics (the differential equation) is similar in both delays (a first order system), but material delay is applied to a flow (material channels / arcs) while information delay is

applied to the information of a state variable (information channels from a level / control arcs with the information of a place).

Material Delay	Information Delay
$\dot{x}_2 = \frac{1}{T_a} (x_2 - x_1)$ (T_a is the delay time)	

Table 2. Sketch, differential equation, FD and ISSCPNs in material and information delays.

Let us suppose another storage system. Sales (which are returns when negative) are proportional (with proportionality constant k) to the difference between the storage reference (r) and the number of stored elements (y). Figure 8 shows the system modelled with a FD and with an ISSCPN respectively.

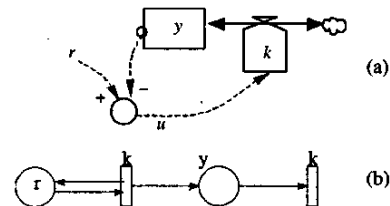

Figure 8. a) DF modelling a simple storage system, b) its equivalent PN.

This system follows the differential equation

$$dy/dt = k \cdot u = -k \cdot y + k \cdot r$$

Whose solution is $y = (y_0 - r) \cdot e^{-kt} + r$, where y_0 is the initial storage. Note that these equations are the same as those of the typical temperature (y) control system, with a temperature reference (r) and error (u) feedback loop.

Let us suppose now a delay in the information feedback loop, that is, the error information u is delayed $1/a$ time units, and x is the variable that represents the delayed signal. If a first order approximation is used to model the delay, the differential equations that drive the system evolution are

$$\begin{aligned} \dot{x} &= -a \cdot x - a \cdot y + a \cdot r \\ \dot{y} &= k \cdot x \end{aligned}$$

And Figure 9 shows the models with FD and PNs respectively.

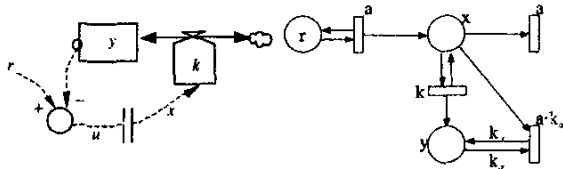

Figure 9. FD and ISSCPN models of a storage system with a first order delay in the information feedback loop.

Note that due to the positivity of PNs, the PN in Figure 9 is not valid for negative values of the state variables (and then of x). And x becomes negative whenever $y(0) > r$. In order to avoid this problem, a reference change of the origin can be made when x is lower bounded: $x = x' - \text{lim}$ where “lim” is a constant that represent a lower bound of x . The equations result then

$$\begin{aligned} \dot{x}' &= -a \cdot x' - a \cdot y + a \cdot r + a \cdot \text{lim} \\ \dot{y} &= k \cdot x' - k \cdot \text{lim} \end{aligned} \quad (2)$$

Figure 10 shows the PN that models the system with the change in the reference origin (or the ODES in (2)).

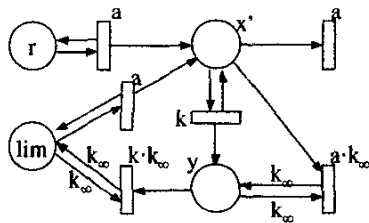

Figure 10. ISSCPN model of the storage system with a state variable change: $x = x' - \text{lim}$

However for this example a better solution to the non-negativity problem exists that can be applied even if x is non bounded. The error u is a non-positive variable but corresponding to the difference between two positive variables: the temperature y and the reference r . Then x can be modelled by two variables, x_r corresponding to the delayed reference and x_y corresponding to the delayed temperature, as can be seen in Figure 11. That model is correct for any (non-negative) initial value, and it is not necessary to know a lower bound of x .

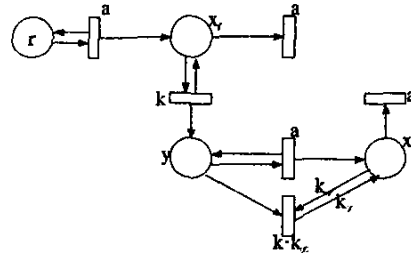

Figure 11. PN modelling a first order information delay in a storage system.

With this first order approximation of a delay, the matrix A of the system and its eigenvalues are,

$$A = \begin{bmatrix} -a & -a \\ k & 0 \end{bmatrix} \quad \frac{-a \pm \frac{1}{2} \sqrt{a^2 - 4ak}}{2}$$

Those eigenvalues have always a real negative part, and then the unforced system is stable for any finite delay time. It is well known that a third order approximation delay is more similar to a pure delay, and it can cause unstable behaviours (poles with positive real part). Figure 12 shows the FD of the third order delay system and the corresponding ODES.

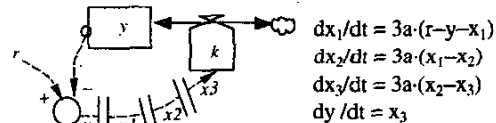

Figure 12. DF modelling a system of storage with information delay, and its equivalent ODES.

This ODES becomes unstable when the delay grows, and then negative states appear. However the state variable, which represents stored elements, has a positive nature. Then the system must be constrained to nonnegative states ($y \geq 0$) to obtain a correct model. This ODES (or FD) with nonnegative constraint have the same behaviour as the ISSCPN model, which is shown in Figure 13.

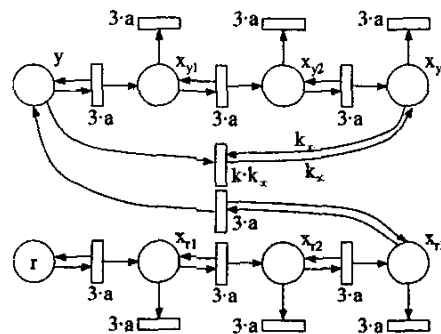

Figure 13. PN modelling a third order delay.

Figure 14 shows simultaneously, as Figure 7 did in the last example, the evolution of the constrained system (PNs and FD with explicit constraints) and the non-restricted one (ODES and FD without explicit constraints). Both behaviours are again similar from the initial state to the first intersection with the horizontal axis (point *a* in the graphic). With PN, by a change of the reference, an evolution similar to the one of the non-restricted system can be simulated from the initial point to the intersection with any axis parallel to the horizontal axis. And this parallel axis can be as negative as we want. This is interesting from the point of view of the expressive power of ISSCPNs. However, PN have positive nature, and then their application field are positive systems, or systems that could be transformed into an equivalent positive system with a physical meaning.

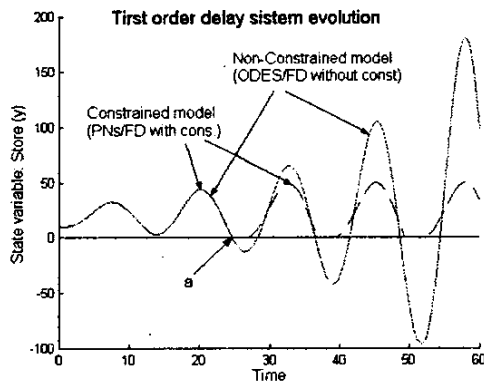

Figure 14. First order delay system evolution in constrained and non-constrained models.

5 Conclusions

A relaxed continuous view of discrete event systems, continuous Petri nets, have been considered together with Forrester Diagrams and linear ordinary differential equation systems (mainly positive systems). They have been compared in order to obtain a deeper knowledge of the expressiveness of the continuous relaxation of PN under infinite server semantics.

Continuous Petri nets under infinite server semantics lead piecewise linear systems provided with nonnegative state and outputs (they have an internal or implicit constraint of non-negativity).

Control arcs weighted with factor k are an abbreviation in infinite server semantics continuous PN, and allow to simulate bounded positive linear systems (eventually under certain transformations). But the behaviour and expressive power of infinite server semantics continuous PN are not restricted to bounded linear positive systems. In fact, any bounded linear system (positive or not) can be shifted to the positive reals and therefore modelled by a infinite server semantics continuous PN. In particular pure oscillatory

behaviours can be modelled with infinite server semantics continuous PN.

Ideal control arcs constitute an extension for infinite server semantics continuous PN (are the control arcs k weighted with factor ∞). With them its expressive power increases because they permit to simulate any positive linear system (bounded or not) or any one that can be transformed into a positive system.

References

- [1] M. Silva and L. Recalde, "Petri nets and integrality relaxations: A view of continuous Petri nets", *IEEE Trans. On Systems, Man, and Cybernetics*, 32(4):314-327, 2002.
- [2] E. Jiménez, L. Recalde and M. Silva, "Forrester diagrams and continuous Petri nets: A comparative view", In Proc. Of the 8th IEEE Int. Conf. On Emerging Technologies and Factory Automation (ETFA 2001), Nize, pp 85-94, 2001.
- [3] M. Silva and L. Recalde, "Unforced Continuous Petri Nets and Positive Systems. Positive Systems", Proc. First Multidisciplinary International Symposium on Positive Systems: Theory and Applications (POSTA 2003), 294, pp55-62, 2003
- [4] T. Murata, "Petri nets: Properties, analysis and applications", Proc.of the IEEE, 77(4):541-580, 1989.
- [5] M. Silva. "Introducing Petri nets", *Practice of Petri Nets in Manufacturing*, p.1-62. Ch.& H., 1993.
- [6] L. Recalde and M. Silva, "PN fluidification revisited: Semantics and steady state", *APII-JESA*, 35(4):435-449, 2001
- [7] H. Alla and R. David, "Continuous and hybrid Petri nets", *Journal of Circuits, Systems, and Computers*, 8(1):159-188, 1998.
- [8] Jay W. Forrester, *Industrial Dynamics*. MIT Press, Mass, Cambridge, 1961.
- [9] L. Farina and S. Rinaldi, *Positive Linear Systems. Theory and Applications. Pure and Applied Mathematics*, John Wiley and Sons, New York, 2000.