

Optimization of the electric power generated by a brake of water

E. Martínez Prado, P. Lara Santillán, A. Falces de Andrés, M. Mendoza Villena, A. Yangüas Peña

¹ Department of Electrical Engineering
E.T.S.I.I., La Rioja University
C/ Luis de Ulloa, 20, 26004 Logroño (Spain)
Phone/Fax number:+0034 941299491, e-mail: pedro.lara@unirioja.es,

Abstract. This article shows a new method designed to predict and optimize electric power generation by means of water control.

It is about optimizing the sustainable use of the hydroelectric resources within a basin. Although, the primary purpose of the extracted water is not exactly for energy generation, but for the purpose of obtaining drinkable water to for human consumption.

This use implies that only the water to be used needs to be processed, therefore treatment costs are minimized and the ecological conservation of the fluvial basin is of maximum importance.

To predict amount of electric power to be generated, the demands of the consumers consumption and the cost of the maintenance of the water-treatment plant, are taken into account.

In order to guarantee water supply to the population, there is an intermediate deposit, the level of which should always be regulated above minimum capacity to guarantee water supply at all times in the event of mishap or accident.

Key words

Hydraulic energy, prediction of the generation, optimization, sustainable development.

1. Introduction

On some occasions the use of the hydrological resources is not produced at the same level as the extraction of those resources.

This difference in level implies an energy potential energy that can be substantial at times, that should be added when the difference is negative or extracted when this energy is positive; in the latter case, if it is not extracted from the water it can damage the processing facilities. This “stopping” of the water can be achieved by using a valve, or alternatively, by a process of energy transformación. This latter process can be implemented by means of a Small hydroelectric power station, provided the heights and flows allow it.

This latter process is the cape at Logroño City Council’s Treatment of Drinking water plant (ETAP). Here, prior to the treatment of drinking water, the water is “stopped” by means of a Small hydroelectric power station to the network.

After this, the water is Purified and it is stored to guarantee water supply for human consumption, even in the cape of mishap in ETAP. But it must also be remembered that water storage overs an excessively long time can be detrimental to its properties and the management of resources should be considered.

The current philosophy of water usage is based on the extracting only what is needed from the river bed. This way when the volume of the stored water descends below a minimums, which garrantees a reserve time, the flow of water into the water plant is increased manually and when the volume incresses, the flow is decreased. This means that an estimation of water consumption is not based exactly on a prediction, but rather it is based on the evolution of the intermediate deposit and on the experience of the technicians.

If water consumption is estimated an forecats ti would be possible to spin this volumene of water based on the optimization of the energy production or of any other factor. This project is centred on looking for the production of maximum energy, for a given volume, studying the factors that intervене in electric consumptions as well as the procutive process as in the generation of electric power itself.

2. Work methodology

In order to archieve an optimization method it is necessary to have assessment models for resources and consumptions.

Resources depend obviously on the water in demand[1] and teh management capcity of storage.

As regards the volume demanded, it doesn’t only depend on the time of the year, but olso on human consumption as a social factor[2]. This latter factor habits and even

the proportion of landscaped surfaces are implied; as are crops which uniply an area of water evaporation[3]. Neither should we forget that a part of the consumption of water is due to the industrial sector.

In regard to the energy consumption, this is due to the production process of water treatment itself. In the latter, the volume of water and its quality on entering the plant are of the greatest importance; depending on the quality of the water, the connection between the volumes of water on entering and on leaving the plant can suffer vanations of more than 5%.

The quality of the water on entering; assuming there are no external hazards, depends on precipitations and flows from the rivers. Being topics object of several prediction studies [4], [5], [6], [7], [8].

With a forecast of resources, a plan can be drawn up to estimate the consumption associated with the process.

The power injected from the electric supply is the difference between them, as shows in the figure 1.



Figura 1. Simplified layout of the generation installation and consumption

3. Calculation of the yield curve

The yield curve of the installation is found in the association of the optimisation of energy production.

The global yield of the installation for each operation point will be the product of the yields of each one of the implicit elements in the production and transformation of the electric power. The figure 2 presents the individual yield curves of the transformer and of the turbine-generator group.

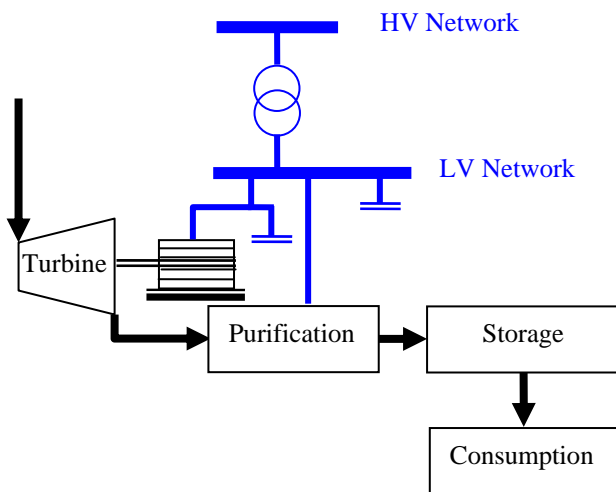
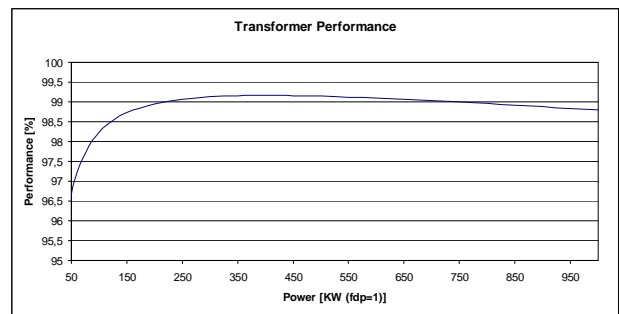

a) Transformer Performance

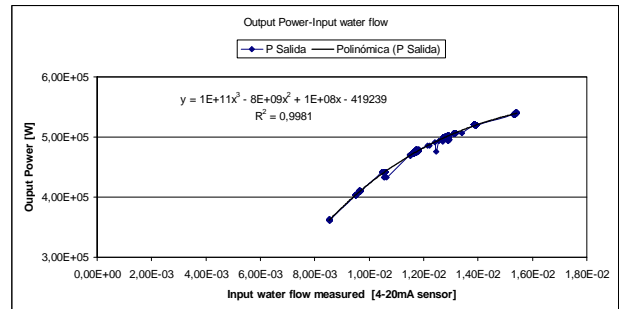

b)

Figure 2. Curves of yield of the transformer and of the turbine-generator group.

The yield curve of the turbine-generator group was always obtained in an experimental way, based on a synchronized measure of the flow turbinado and the generated power; the figure 3 shows the measure synchronized on the installation, in it, the measure of the flow is represented on the exit of a current knot 4-20 mA.

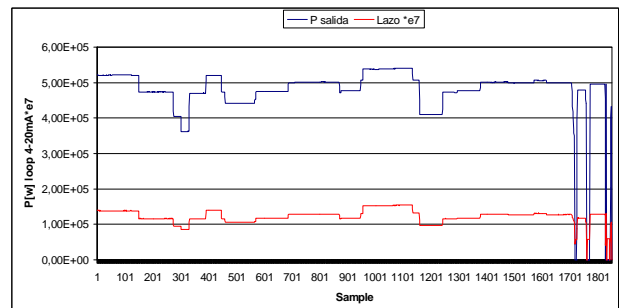

Figure 3. shows the synchronized measurement an the installation, Power and loop 4-20mA

The yield function by joining the transformer to the network can be obtained from the manufacturer's test protocol. To calculate the operation point of the machine, must be taken into account.

The lower side off the transformer is connected to the generator and the processing plant. This means, the yield of the transformer will depend as much on the volume of the turbined water, as on the degree of purity of the water in the purification process.

In order to evaluate the energy cost of the purification of the unitary volume of water, as well as the consumptions, a database has been used which contains the following fields: entrance flows and exits, levels of chlorine, PH, turbidity, entrance temperature, flows of detris and deposit levels of purified water storage. To this database registers relative to energy generation and the

climatology of the area of influence of the purifying plant, were added.

With all the previous data the system of optimization 4 worked according to the outline of the figure. In the calculate of the flow of water the periods of turbinación zero they will be avoided, to be harmful mechanically and to impact negatively in the quality of the purification.

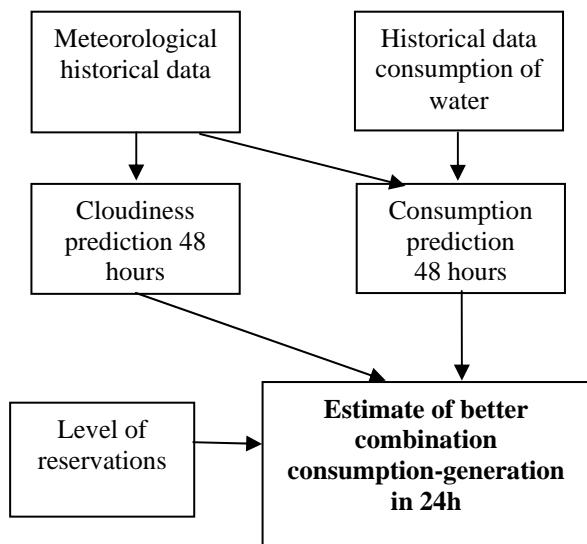

Figure 4. Process of energy optimization.

For the energy predictions an artificial intelligence system is used, which predicts the average water consumption every hour.

The estimate of the volume of water to turbinar goes to evaluate the best combination consumption-generation. By means of an artificial intelligence module it is determined if you turbine exactly the water that is needed or if you turbine a different quantity to be able to take advantage of the best characteristics in the entrance water during the most favorable periods.

4. Prediction system description

In this Project diffused neuro models were tested ANFIS (Adaptive Neuro-Fuzzy training of Sugeno-type Inference System).

The ANFIS system is based on an input/output series, a combination of IF-THEN and a diffused interference system with a layered structure (Figure 5). On the first layer, each node has a function in a bell form or Gauss function. On the second layer cross products of membership function is carried out. On the third layer, the trigger force of the i -th rule is calculated. Layer four, applies the resulting parameters of the input and applied the trigger force of the rule calculated on the previous layer is taken unto account, on the fifth and final layer an aggregate an evaluation is made.

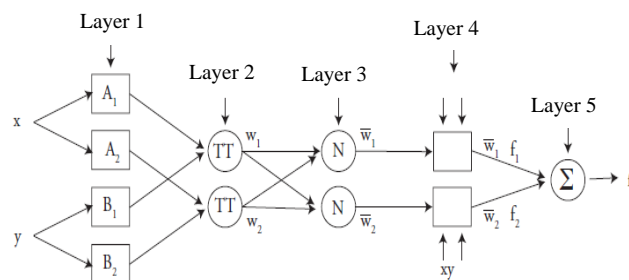

Figure 5. the ANFIS system, SUGENO type is based on the rules of hybrid learn system.

The data base of input/output is divided into two blocks, the first is used to train de system, while the second is used to test the results and detect errors.

As input the hour, temperature, rainfall and Solar radiation, AirSpeed, Pressure. Were taken. As output, the average water flow at hourly intervals, was obtained.

The system was assessed in different settings. On the first a complete database was taken without taking into account the day of the week. Latterly a second setting differentiated the days of the week, tables I-II shows the rules and errors for each of the settings. In figure 6 different profiles of predicted consumption which come closer to profiles of real consumption can be seen. Figure 7 shows how the training values come closer to de values predicted.

Table I. Range of influence impact on number of rules and RMSE

Input	range of influence	Rules	RMSE
Hour,Temp,Vair,SolarRad	0.1	150	45
Hour,Temp,Vair,SolarRad	0.2	116	50
Hour,Temp,Vair,SolarRad	0.3	66	75
Hour,Temp,Rainfall,SolarRad	0.3	60	75
Hour,Temp,Rainfall,SolarRad	0.4	33	80

Table II. Number of rules and error for the days of the week

Day of the Week	n° rules	Error %	RMSE
M, Tu, W, Th	33	0.61%	80.06
F, Sa	33	0.46%	75.8
Su and Bank Holiday	30	0'3	60

Where:

- Error: the mean error in percentage, show how the system nullifies peaks in consumption.
- RMSE: Root mean square error taking into account that maximum average is greater than 1200 ltrs/seg. Does not imply a large quantity.

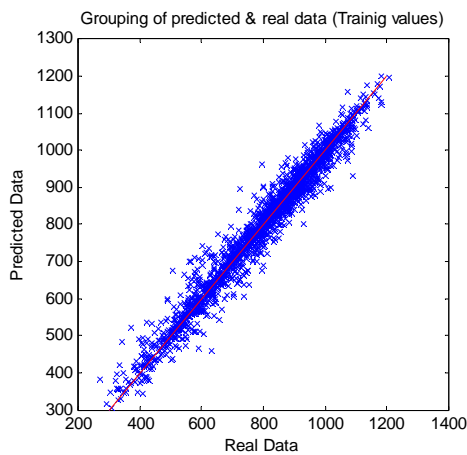

Figure 6: grouping of predicted data, opposed to real training values.

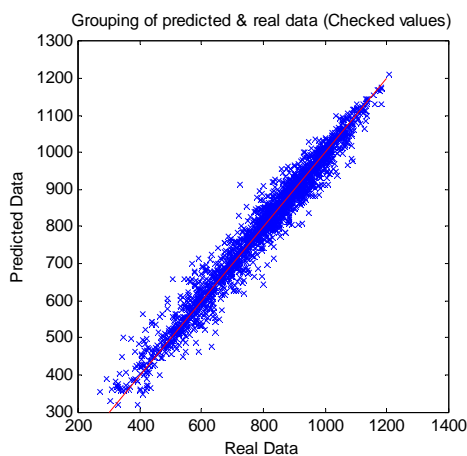

Figure 7: grouping of predicted data, opposed to real checked values.

In order to maximize energetic performance, some basic rules of work are created which evaluate water flow to be spun in each part of the day depending on the performance curve between the turbine and the generator, taking into account the relative situation between the maximum flow, the average flow analysed each part of the day and volume restrictions of the intermediate deposit of treated water.

5. Further Information

As far as this line of work is concerned, several future actions are anticipated, in terms of energy and also of a social nature.

In terms of energy, it is necessary to highlight a relative study to the optimization of the economic-energy yield of the installation.

On a social level, the optimization of such factors as quality of the outgoing water and minimum usage of chemical products, are factors to be considered.

When all these studies are complete, the final step will be to create a tool of optimization multi-factor optimization tool, which will allow to associate energetic, economic

and social factors to be evaluated within the productivity process.

5. Conclusions

This paper has presented a study of optimization of an energy hydroelectric source, from the point of view of the environmental sustainability.

The study is based on the prediction of the demand of water on the part of the consumers as well as of the previous biometric characteristics of the same one to suffer the purification process.

The amplification of the present study to an optimization multi-agent will allow to improve the sustainability of the productive system in the widest sense in the world.

Acknowledgement

It is wanted to be grateful to the City council of Logroño for all the facilities lent in the realization of the present work.

References

- [1] Narate Lertpalangsunti, Christine W. Chan, Ralph Mason, Paitoon Tontiwachwuthikul, "A toolset for construction of hybrid intelligent forecasting systems: application for water demand prediction", Elsevier Journal of Artificial Intelligence in Engineering 13 (1999), pp 21-42.
- [2] C. Fox, B.S. McIntos, P. Jeffrey, "Classifying households for water demand forecasting using physical property characteristics", Elsevier Journal of Land Use Policy 26 (2009), pp 558-568.
- [3] Y.H. Li, Y.L. Cui, "Real-time forecasting of irrigation water requirements of paddy fields", Elsevier Journal of Agricultural Water Management 3 I (1996) 185-193.
- [4] Amir F. Atiya, Suzan M. El-Shoura, Samir I. Shaheen, Mohamed S. El-Sherif, "A Comparison Between Neural-Network Forecasting Techniques—Case Study: River Flow Forecasting", IEEE Transactions On Neural Networks, VOL. 10, NO. 2, MARCH 1999, pp 402-409.
- [5] Giorgio Corani, Giorgio Guariso, "Coupling Fuzzy Modeling and Neural Networks for River Flood Prediction", IEEE Transactions On Systems, Man, And Cybernetics—PART C: APPLICATIONS AND REVIEWS, VOL. 35, NO. 3, AUGUST 2005, pp 382-390.
- [6] Turgay Partal, O'zgu'r Kis_i, "Wavelet and neuro-fuzzy conjunction model for precipitation forecasting", Elsevier Journal of Hydrology (2007) 342, 199-212.
- [7] Robert C. Jung, A.R. Tremayne, "Coherent forecasting in integer time series models", Elsevier International Journal of Forecasting 22 (2006), pp 223-238.
- [8] J.M. Molina, P. Isasi, A. Berlanga, A. Sanchis, "Hydroelectric power plant management relying on neural networks and expert system integration", Elsevier Journal of Engineering Applications of Artificial Intelligence 13 (2000), pp 357-369.